

General catalogue



OPTICAL SCALES

MAGNETIC SCALES

ROTARY ENCODERS

DIGITAL READOUTS

POSITION CONTROLLERS



GIVI MISURE

Measuring and control systems

Index

Optical scales

4

ISA 2320	Incremental optical scale of small overall dimensions
SCR 3923	Multipurpose incremental optical scale
PBS-HR	Self-aligned incremental optical scale
GMS	Incremental modular optical scale
NCS	Incremental optical scale for CNC applications
NCH	Exposed incremental optical scale, with no contact



Magnetic scales

13

MTS	Reading system with square-wave output
MTV	Reading system with sine-wave output (1 Vpp)
ME110	Single-axis digital readout
MP	Magnetic bands for MTS and MTV sensors
ACCESSORIES	Cover and support



Rotary encoders

19

EN58	Incremental encoders \varnothing 58 mm
EN38	Incremental encoders \varnothing 38 mm
EPC	Rack and pinion encoder
EN413	Incremental encoder \varnothing 41.3 mm
VE413	Electronic handwheel, various flanges
ACCESSORIES	Metric wheels and supports
ACCESSORIES	Shaft-encoder couplings



Digital readouts

26

ME510	Single-axis digital readout
ME518	Single-axis digital readout, with 7-digit display
ME600	Multi-axis digital readout, without auxiliary display
ME800	Multi-axis digital readout, with auxiliary LCD display
VI700	Multi-axis digital readout, with LED display
VI900	Multi-axis digital readout, touch screen color LCD
ACCESSORIES	Supporting arms



Position controllers

37

THESI 310	Single-axis position controller
THESI 320	Two-axis position controller



The history of GIVI MISURE

GIVI MISURE was established in 1979. In the following years, thanks to the steady stream of investments for promoting the development of new products, the Company made a name for itself in increasingly significant market segments both in Italy and abroad. In 1991 the share parcels of Sipe Automazione, company manufacturing digital readouts, and Metromil, manufacturing encoders, were acquired.

The re-processing of the know-how then gave further thrust to the design of opto-electronic and magnetic devices, which in 1993 won acknowledgements awarded by the Milan Chamber of Commerce for their technological innovations. In 1995 **GIVI MISURE** moved to their new premises in Nova Milanese. In 1997 an additional important acknowledgement was achieved with certification according to ISO 9001, then turned into ISO 9001:2000 in 2003.

In 2003 **GIVI MISURE PVT. LTD** was established in India.

In its 30 years of life, **GIVI MISURE** has given a positive contribution to technological growth, taking a leading position in some industrial sectors and gaining wide recognition in worldwide markets.

The products



Optical scales

High precision is the key feature of optical scales manufactured by **GIVI MISURE**. In addition to models **ISA** and **SCR**, specific for applications on Machine-tools and manufacturing Machines, models **PBS** for synchronized Press brakes, **NCH** for Coordinate Measuring Machines and **NCS** for CNC Machines were introduced. Transducers are selected after passing thermal and dynamic tests, consequently they can withstand continuous, heavy-duty working conditions.



Magnetic scales

MTS-MTV transducers and **MP100-200-500** magnetic bands allow an economical and easy application even on Machines working in conditions of extreme environmental dirt. Reading of magnetic track is performed with no contact at such a mounting distance from the transducer that it can accept sensible track/carriage coupling errors. The speed and acceleration values that the measuring system is able to withstand are considerable. The **ME110** measuring system, in the self-powered version, is particularly suitable for applications on low-cost or portable Machines.



Rotary encoders

Four production lines are currently available. The body of encoders model **EN600**, **EN500** and **EN413** is made of aluminium alloy which gives them robustness and good dimensional stability. Signal calibration and quality is also assured in the miniaturized model **EN38**, thanks to the use of mechanical components made of ground stainless steel and to graded ball bearings.



Digital readouts

MERIT and **VISION** are the digital readout models currently under production. They are manufactured with the most advanced electronic technology currently available: low-voltage components (3.3 Volts), minimal consumption and high degree of integration allowing multiple and versatile performances. In addition to their ease of use, a high operational reliability is achieved. All instruments benefit from a long period of after-sales warranty.



Position controllers

The position controllers of series **THESI**, in the 1 or 2 axis versions, use a 16-bit microcontroller, 256K FLASH and 8K RAM memory in single-chip mode. The metal box and the wiring of internal boards assure high protection against magnetic interference. The use of photo-couplers assures the electrical decoupling of inputs and interfacing with encoders. The main use of position controllers is in the sector of sheet-metal cutting Machines.

Technology and quality to satisfy our customers



GIVI MISURE's production site in Nova Milanese (Milan), Italy



Quality system certified in 1994, turned into ISO 9001:2000 in 2003.



METROLOGICAL CONTROL

Measuring of the value of each optical scale is carried out in extremely stable environmental and climatic conditions:
 $T = 20^{\circ}\text{C} \pm 0.1^{\circ}\text{C}$ R.H. = $45 \pm 55\%$.

The one-piece granite optical bench rests on steel balls on the strong supporting structure. The support of the laser head, whose resolution is $0.01 \mu\text{m}$, is of the self-aligning type. The carriage moves along the beam without friction since it is supported on pneumostatic slides.

DYNAMIC TEST

Acceleration of 10 G and a frequency of 5000 Hz are the "prohibitive" dynamic conditions which the devices are subjected to during the design phase and the prototype testing phase. During the vibration tests, displacement, amplitude, count and reference quality of signals are all tested.



Optical scales



Models

- ISA 2320
- SCR 3923
- PBS-HR
- GMS
- NCS
- NCH

ISA 2320 – Incremental optical scale of small overall dimensions

- Reduced size, to allow installation on small machine-tools or for applications with limited installation space.
- Possibility of registration which simplifies alignment and makes use on rough surfaces easy (retrofitting and machines for which application was not foreseen).
- Resolutions up to 0.5 μm . Accuracy $\pm 3 \mu\text{m}$ or $\pm 10 \mu\text{m}$.
- Linear thermal expansion coefficient $\lambda = 10.6 \times 10^{-6} \text{ }^\circ\text{C}^{-1}$ suitable to the application.
- Reference indexes in required positions.
- Protected against inversion of power supply polarity and short circuit on output ports.

ISA 10

Resolution 100 μm

Resolution	100 μm
Grating pitch	400 μm
Accuracy	$\pm 10 \mu\text{m}$
Max. traversing speed	120 m/min
Reference indexes	in required positions
Output	NPN / LINE DRIVER / PUSH-PULL
Protection class	IP 54 standard - IP 64 pressurized

ISA 100

Resolution 10 μm

Resolution	10 μm
Grating pitch	40 μm
Accuracy	$\pm 5 \mu\text{m}$
Max. traversing speed	80 m/min
Reference indexes	in required positions
Output	NPN / LINE DRIVER / PUSH-PULL
Protection class	IP 54 standard - IP 64 pressurized

ISA 5

Resolution 5 μm

Resolution	5 μm
Grating pitch	20 μm
Accuracy	$\pm 3 \mu\text{m}$
Max. traversing speed	60 m/min
Reference indexes	in required positions
Output	NPN / LINE DRIVER / PUSH-PULL
Protection class	IP 54 standard - IP 64 pressurized

ISA W1

Resolution 1 μm

Resolution	1 μm
Grating pitch	40 μm
Accuracy	$\pm 3 \mu\text{m}$
Max. traversing speed	25 m/min
Reference indexes	in required positions
Output	NPN / LINE DRIVER / PUSH-PULL
Protection class	IP 54 standard - IP 64 pressurized

ISA W05

Resolution 0.5 μm

Resolution	0.5 μm
Grating pitch	20 μm
Accuracy	$\pm 3 \mu\text{m}$
Max. traversing speed	12 m/min
Reference indexes	in required positions
Output	NPN / LINE DRIVER / PUSH-PULL
Protection class	IP 54 standard - IP 64 pressurized

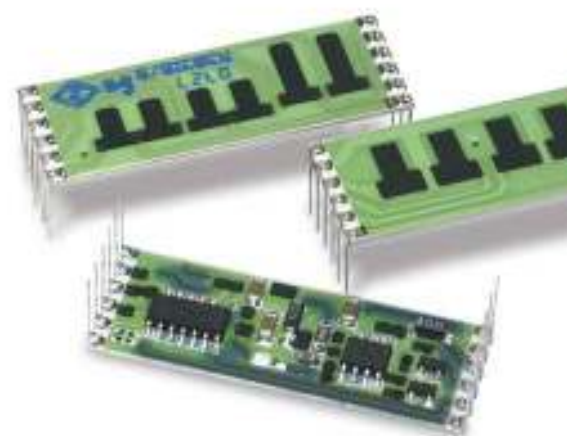

Hybrid ceramic circuit calibrated by laser for generation of signals. Any vibration or thermal variation does not affect the circuit stability.

SCR 3923 – Multipurpose incremental optical scale

- Small overall dimensions. Very strong and rigid because of its wide cross-section. Dimensions 39x23 mm.
- Reinforced connecting cable without external connections. Connector inside the transducer.
- Double protection along the sliding side (four lip seals) made of special anti-wear material for a considerable number of continuous movements.
- Hybrid circuit calibrated by laser. High stability of signals (positive and negative signals from LINE DRIVER).
- Resolutions up to 0.5 μm . Accuracy $\pm 3 \mu\text{m}$ or $\pm 10 \mu\text{m}$.
- Linear thermal expansion coefficient $\lambda = 10.6 \times 10^{-6} \text{ }^\circ\text{C}^{-1}$ suitable to the application.
- One reference index at midpoint or in different required positions.
- Wide alignment tolerances.
- In modular version for measuring length over 6500 mm, or for lower measuring length on request.
- Full possibility to disassemble and reassemble it. Possibility of direct service.
- Protected against inversion of power supply polarity and short circuit on output ports.

SCR 10

Resolution 100 μm

Resolution	100 μm
Grating pitch	400 μm
Accuracy	$\pm 10 \mu\text{m}$
Max. traversing speed	120 m/min
Reference indexes	in required positions
Output	NPN / LINE DRIVER / PUSH-PULL
Protection class	IP 54 standard - IP 64 pressurized

SCR K50

Resolution 50 μm

Resolution	50 μm
Grating pitch	400 μm
Accuracy	$\pm 10 \mu\text{m}$
Max. traversing speed	120 m/min
Reference indexes	in required positions
Output	NPN / LINE DRIVER / PUSH-PULL
Protection class	IP 54 standard - IP 64 pressurized

SCR W10

Resolution 10 μm

Resolution	10 μm
Grating pitch	400 μm
Accuracy	$\pm 10 \mu\text{m}$
Max. traversing speed	120 m/min
Reference indexes	in required positions
Output	NPN / LINE DRIVER / PUSH-PULL
Protection class	IP 54 standard - IP 64 pressurized

SCR 100

Resolution 10 μm

Resolution	10 μm
Grating pitch	40 μm
Accuracy	$\pm 5 \mu\text{m}$
Max. traversing speed	80 m/min
Reference indexes	in required positions
Output	NPN / LINE DRIVER / PUSH-PULL
Protection class	IP 54 standard - IP 64 pressurized



Square-wave output signals from transducer.

Self-regulation of the grating linear extension. The compression springs damp any variation of distance between the two **A** and **B** restraints (integral to the housing and so subject to variations caused by its thermal expansion coefficient, similar to that of the material used in the manufacturing of the machines and other controlling devices). The measurements become homogenous and relative to the temperature of 20°C (68°F).



SCR K5 Resolution 5 µm

Resolution	5 µm
Grating pitch	40 µm
Accuracy	± 5 µm
Max. traversing speed	80 m/min
Reference indexes	in required positions
Output	NPN / LINE DRIVER / PUSH-PULL
Protection class	IP 54 standard - IP 64 pressurized

SCR 5 Resolution 5 µm

Resolution	5 µm
Grating pitch	20 µm
Accuracy	± 3 µm
Max. traversing speed	60 m/min
Reference indexes	in required positions
Output	NPN / LINE DRIVER / PUSH-PULL
Protection class	IP 54 standard - IP 64 pressurized



Mounting kit of the optical scale in modular version for applications on big-sized machines.

SCR W1 Resolution 1 µm

Resolution	1 µm
Grating pitch	40 µm
Accuracy	± 3 µm
Max. traversing speed	25 m/min
Reference indexes	in required positions
Output	NPN / LINE DRIVER / PUSH-PULL
Protection class	IP 54 standard - IP 64 pressurized

SCR W05 Resolution 0.5 µm

Resolution	0.5 µm
Grating pitch	20 µm
Accuracy	± 3 µm
Max. traversing speed	12 m/min
Reference indexes	in required positions
Output	NPN / LINE DRIVER / PUSH-PULL
Protection class	IP 54 standard - IP 64 pressurized



Example of certificate of metrological inspection which is supplied with every optical scale.

PBS-HR – Self-aligned incremental optical scale

New

- Optical scale with stainless steel grating for applications on synchronized Press brakes.
- Self-aligned reading transducer. Resolutions up to 0.5 μm , accuracy $\pm 2.5 \mu\text{m}$.
- Linear thermal expansion coefficient $\lambda = 10.6 \times 10^{-6} \text{ }^\circ\text{C}^{-1}$ suitable to the application.
- Reference indexes at coded distance or at constant step (10 mm) or selectable. The selectable zero references and the swinging cable output make the scale **SYMMETRIC** and applicable, in the same version, both to the right column and to the left column of the Press brake.
- Hybrid circuit calibrated by laser. High stability of signals (positive and negative signals from LINE DRIVER).
- Protected against inversion of power supply polarity and short circuit on output ports.

PBS-HR T10

Resolution 10 μm - Zero Magneto Set

Resolution	10 μm
Grating pitch	40 μm
Accuracy	$\pm 2.5 \mu\text{m}$
Max. traversing speed	80 m/min
Measuring length	170, 220, 270, 320, ... mm
Reference indexes	constant step / selectable / coded
Output	LINE DRIVER / PUSH-PULL
Protection class	IP 54 standard - IP 64 pressurized
Electrical protections	inversion of polarity and short circuit



PBS-HR 100Z

Resolution 10 μm

Resolution	10 μm
Grating pitch	40 μm
Accuracy	$\pm 2.5 \mu\text{m}$
Max. traversing speed	80 m/min
Measuring length	170, 220, 270, 320, ... mm
Reference indexes	in required positions
Output	LINE DRIVER / PUSH-PULL
Protection class	IP 54 standard - IP 64 pressurized
Electrical protections	inversion of polarity and short circuit



All optical scales are supplied with a certificate of metrological inspection performed in rigorous environmental and climatic conditions: T = 20°C \pm 0.1°C R.H. = 45 + 55 %.

PBS-HR T5

Resolution 5 μm - Zero Magneto Set

Resolution	5 μm
Grating pitch	20 μm
Accuracy	$\pm 2.5 \mu\text{m}$
Max. traversing speed	60 m/min
Measuring length	170, 220, 270, 320, ... mm
Reference indexes	constant step / selectable / coded
Output	LINE DRIVER / PUSH-PULL
Protection class	IP 54 standard - IP 64 pressurized
Electrical protections	inversion of polarity and short circuit

PBS-HR 5Z

Resolution 5 μm

Resolution	5 μm
Grating pitch	20 μm
Accuracy	$\pm 2.5 \mu\text{m}$
Max. traversing speed	60 m/min
Measuring length	170, 220, 270, 320, ... mm
Reference indexes	in required positions
Output	LINE DRIVER / PUSH-PULL
Protection class	IP 54 standard - IP 64 pressurized
Electrical protections	inversion of polarity and short circuit

PBS-HR T1 PBS-HR S1

Resolution 1 μm - Zero Magneto Set

**CANopen
version**

	PBS-HR T1	PBS-HR S1 (CANopen version)
Resolution	1 μm	1 μm
Grating pitch	20 μm	20 μm
Accuracy	$\pm 2.5 \mu\text{m}$	$\pm 2.5 \mu\text{m}$
Max. traversing speed	40 m/min	40 m/min
Measuring length	170, 220, 270, 320, ... mm	170, 220, 270, 320, ... mm
Reference indexes	constant step / selectable / coded	not needed
Output	LINE DRIVER / PUSH-PULL	CANopen
Protection class	IP 54 standard - IP 64 pressurized	IP 54 standard - IP 64 pressurized
Electrical protections	inversion of polarity and short circuit	inversion of polarity and short circuit

PBS-HR T05

Resolution 0.5 μm - Zero Magneto Set

Resolution	0.5 μm
Grating pitch	20 μm
Accuracy	$\pm 2.5 \mu\text{m}$
Max. traversing speed	25 m/min
Measuring length	170, 220, 270, 320, ... mm
Reference indexes	constant step / selectable / coded
Output	LINE DRIVER / PUSH-PULL
Protection class	IP 54 standard - IP 64 pressurized
Electrical protections	inversion of polarity and short circuit

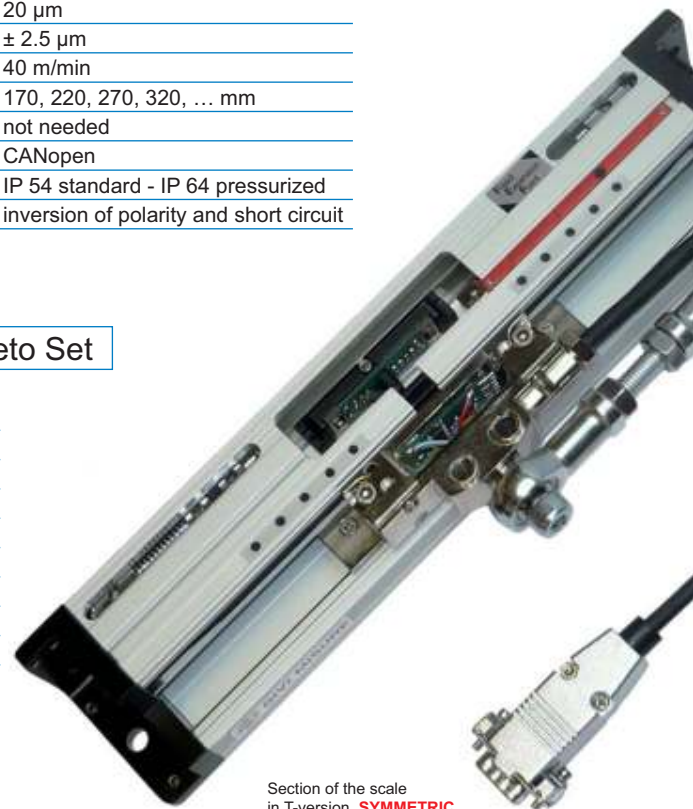

Section of the scale
in T-version, **SYMMETRIC**.

GMS – Incremental modular optical scale

- Modular optical scale with stainless steel grating, particularly suitable for long strokes (ML up to 30040 mm).
- Rugged and heavy profile, in anodized aluminium.
- Coupling gaskets between the modules for a better fit of mechanical parts (in case of disassembly and reassembly).
- Resolutions up to 0.1 μm . In the T version resolutions are programmable (**Pr**) via serial line.
- Accuracy grade $\pm 10 \mu\text{m}$.
- Linear thermal expansion coefficient $\lambda = 10.6 \times 10^{-6} \text{ }^\circ\text{C}^{-1}$ suitable to the application.
- Reference indexes at coded distance, or at constant step (50 mm) or selectable.
- Sine-wave or TTL signal output.
- Protected against inversion of power supply polarity and short circuit on output ports.

GMS V40

Sine-wave output

Resolution	up to 0.1 μm
Grating pitch	40 μm
Accuracy	$\pm 10 \mu\text{m}$
Max. traversing speed	120 m/min
Measuring length	up to 30040 mm at pitches of 200 mm. Sectional modules of different lengths
Reference indexes	at constant step (50 mm), selectable by a magnet or at coded distance (80 mm)
Output	sine wave 1 Vpp
Protection class	IP 54 standard - IP 64 pressurized
Electrical protections	inversion of polarity and short circuit



Sine-wave output signals from transducer.

GMS T

TTL output

Resolution	10 - 5 - 2 - 1 - 0.5 μm
Grating pitch	40 μm
Accuracy	$\pm 10 \mu\text{m}$
Max. traversing speed	120 m/min
Measuring length	up to 30040 mm at pitches of 200 mm. Sectional modules of different lengths
Reference indexes	at constant step (50 mm), selectable by a magnet or at coded distance (80 mm)
Output	LINE DRIVER / PUSH-PULL
Protection class	IP 54 standard - IP 64 pressurized
Electrical protections	inversion of polarity and short circuit

Pr



NCS – Incremental optical scale for CNC applications

- Optical scale with glass measuring support. Resolutions up to 0.1 μm . In the T version resolutions are programmable (**Pr**) via serial line.
- Accuracy grade $\pm 3 \mu\text{m}$. Metrological certificate provided with every scale.
- Linear thermal expansion coefficient $\lambda = 8 \times 10^{-6} \text{ }^\circ\text{C}^{-1}$.
- Swinging connecting cable output (connector inside the transducer).
- Reference indexes at coded distance or at constant step (40 mm) or selectable.
- High stability and quality of signals even in case of high speed, strong accelerations and vibrations.
- Protected against inversion of power supply polarity and short circuit on output ports.

NCS V20

Sine-wave output

Resolution	up to 0.1 μm
Grating pitch	20 μm
Accuracy	$\pm 3 \mu\text{m}$
Max. traversing speed	120 m/min
Measuring length	70 to 3240 mm
Reference indexes	constant step / selectable / coded
Output	sine wave 1 Vpp
Protection class	IP 54 standard - IP 64 pressurized
Electrical protections	inversion of polarity and short circuit



NCS T5

TTL output – Resolution 5 μm

Resolution	5 μm
Grating pitch	20 μm
Accuracy	$\pm 3 \mu\text{m}$
Max. traversing speed	120 m/min
Measuring length	70 to 3240 mm
Reference indexes	constant step / selectable / coded
Output	LINE DRIVER / PUSH-PULL
Protection class	IP 54 standard - IP 64 pressurized
Electrical protections	inversion of polarity and short circuit

Pr

NCS T1

TTL output – Resolution 1 μm

Resolution	1 μm
Grating pitch	20 μm
Accuracy	$\pm 3 \mu\text{m}$
Max. traversing speed	120 m/min
Measuring length	70 to 3240 mm
Reference indexes	constant step / selectable / coded
Output	LINE DRIVER / PUSH-PULL
Protection class	IP 54 standard - IP 64 pressurized
Electrical protections	inversion of polarity and short circuit

Pr

NCS T05-T01

TTL output – Resolution 0.5-0.1 μm

	T05	T01
Resolution	0.5 μm	0.1 μm
Grating pitch	20 μm	20 μm
Accuracy	$\pm 3 \mu\text{m}$	$\pm 3 \mu\text{m}$
Max. traversing speed	120 m/min	45 m/min
Measuring length	70 to 3240 mm	
Reference indexes	constant step / selectable / coded	
Output	LINE DRIVER / PUSH-PULL	
Protection class	IP 54 standard - IP 64 pressurized	
Electrical protections	inversion of polarity and short circuit	

Pr



NCH – Exposed incremental optical scale, with no contact

- Reading transducer made of die-cast metallic material, of small overall dimensions.
- Stainless steel grating. Dimensions 18x0.305 mm in a single section.
- Double fixing system of the reading transducer, horizontally or vertically.
- Very flexible connecting cable.
- High stability of signals.
- Wide alignment tolerances.

NCH T10Z - W10

Resolution 10 μm

	T10Z	W10
Resolution	10 μm	10 μm
Grating pitch	200 μm	400 μm
Accuracy	$\pm 5 \mu\text{m}$	$\pm 5 \mu\text{m}$
Transducer-grating distance	0.5 mm	0.8 mm
Max. traversing speed	300 m/min	120 m/min
Reference indexes	at constant step (50 mm)	not available
Output	LINE DRIVER	LINE DRIVER / PUSH-PULL
Protection class	IP 40	IP 40



NCH T5Z - W5

Resolution 5 μm

	T5Z	W5
Resolution	5 μm	5 μm
Grating pitch	200 μm	200 μm
Accuracy	$\pm 5 \mu\text{m}$	$\pm 5 \mu\text{m}$
Transducer-grating distance	0.5 mm	0.5 mm
Max. traversing speed	210 m/min	120 m/min
Reference indexes	at constant step (50 mm)	not available
Output	LINE DRIVER	LINE DRIVER / PUSH-PULL
Protection class	IP 40	IP 40

NCH T1Z

Resolution 1 μm

Resolution	1 μm
Grating pitch	200 μm
Accuracy	$\pm 5 \mu\text{m}$
Transducer-grating distance	0.5 mm
Max. traversing speed	120 m/min
Reference indexes	at constant step (50 mm)
Output	LINE DRIVER
Protection class	IP 40



Magnetic scales



Models

- MTS
- MTV
- ME110
- MP100
- MP200
- MP200Z
- MP500
- ACCESSORIES

MTS – Reading system with square-wave output

- MTS magnetic sensor of small overall dimensions. Resolutions up to 0.5 µm programmable (**Pr**) via serial line.
- Zero references in required positions (with MP200Z only).
- Magnetic body sensor made of die-cast metallic material.
- Fixing of magnetic sensor by threaded holes M4 which can also be considered as through holes for M3 screws.
- Wide alignment tolerances.
- Protected against inversion of power supply polarity and short circuit on output ports.

MTS P

Pole pitch 1+1 mm

Pr

Pole pitch	1+1 mm
Available resolutions	10 - 5 - 1 - 0.5 µm
Accuracy	± 10 µm
Sensor - magnetic band gap	0.1 + 0.5 (with band MP100)
Reference signal	at constant pitch of 1 mm (C)
Repeatability	± 1 increment
Output	LINE DRIVER / PUSH-PULL
Power supply	5 + 28 Vdc ± 5%
Max. frequency	300 kHz
Max. speed	0.6 m/s (MTS P05) – 1.2 m/s (MTS P1)
Protection class	IP 67
Electrical protections	inversion of polarity and short circuit



MTS M

Pole pitch 2+2 mm

Pr

Pole pitch	2+2 mm
Available resolutions	1000 - 500 - 100 - 50 - 25 - 10 - 5 - 1 µm
Accuracy	± 15 µm
Sensor - magnetic band gap	0.3 + 1.5 (with band MP200) 0.35 + 0.9 (with band MP200Z)
Reference signal	at constant pitch of 2 mm (C) external (E) positioned on the magnetic band (Z)
Repeatability	± 1 increment
Output	LINE DRIVER / PUSH-PULL
Power supply	5 + 28 Vdc ± 5%
Max. frequency	300 kHz
Max. speed	1.2 m/s (MTS M1) – 12 m/s (MTS M10)
Protection class	IP 67
Electrical protections	inversion of polarity and short circuit

MTS H

Pole pitch 5+5 mm

Pr

Pole pitch	5+5 mm
Available resolutions	100 - 50 - 25 - 10 - 5 µm
Accuracy	± 40 µm
Sensor - magnetic band gap	0.3 + 3.5 (with band MP500)
Reference signal	at constant pitch of 5 mm (C) external (E)
Repeatability	± 1 increment
Output	LINE DRIVER / PUSH-PULL
Power supply	5 + 28 Vdc ± 5%
Max. frequency	300 kHz
Max. speed	6 m/s (MTS H5) – 12 m/s (MTS H10)
Protection class	IP 67
Electrical protections	inversion of polarity and short circuit



Sensors, magnetic bands and covers are wrapped in a functional package which protects them during transport.

MTV – Reading system with sine-wave output (1 Vpp)

- MTV magnetic sensor of small overall dimensions.
- Magnetic body sensor made of die-cast metallic material.
- Fixing of magnetic sensor by threaded holes M4 which can also be considered as through holes for M3 screws.
- Wide alignment tolerances.
- Protected against inversion of power supply polarity and short circuit on output ports.

MTV P

Pole pitch 1+1 mm

Pole pitch	1+1 mm
Resolution	up to 0.1 μ m
Accuracy	\pm 10 μ m
Sensor - magnetic band gap	0.1 + 0.5 (with band MP100)
Reference signal	at constant pitch of 1 mm (C)
Repeatability	\pm 1 increment
Output	sine wave 1 Vpp
Power supply	5 + 28 Vdc \pm 5%
Max. frequency	12 kHz
Max. speed	12 m/s
Protection class	IP 67
Electrical protections	inversion of polarity and short circuit

MTV M

Pole pitch 2+2 mm

Pole pitch	2+2 mm
Resolution	up to 0.5 μ m
Accuracy	\pm 15 μ m
Sensor - magnetic band gap	0.3 + 1.5 (with band MP200) 0.35 + 0.9 (with band MP200Z)
Reference signal	at constant pitch of 2 mm (C) external (E)
Repeatability	\pm 1 increment
Output	sine wave 1 Vpp
Power supply	5 + 28 Vdc \pm 5%
Max. frequency	6 kHz
Max. speed	12 m/s
Protection class	IP 67
Electrical protections	inversion of polarity and short circuit

MTV H

Pole pitch 5+5 mm

Pole pitch	5+5 mm
Resolution	up to 1 μ m
Accuracy	\pm 40 μ m
Sensor - magnetic band gap	0.3 + 3.5 (with band MP500)
Reference signal	at constant pitch of 5 mm (C) external (E)
Repeatability	\pm 1 increment
Output	5 + 28 Vdc \pm 5%
Power supply	sine wave 1 Vpp
Max. frequency	2.4 kHz
Max. speed	12 m/s
Protection class	IP 67
Electrical protections	inversion of polarity and short circuit

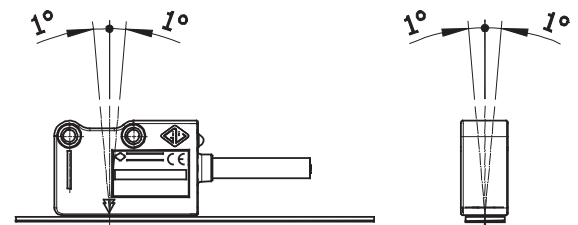

Sensor alignment tolerances.



ME110 – Single-axis digital readout

- Digital readout with double fixing possibility: on bench or built-in.
- Several user-friendly functions available.
- Power supply either via battery or mains supply.
- Magnetic body sensor made of metal, of small overall dimensions.
- Fixing of magnetic sensor by threaded holes M4 which can also be considered as through holes for M3 screws.
- Flexible cable max. length 4 m.
- Wide alignment tolerances.
- To be used with magnetic band **MP200** or **MP100**.

ME110 2B

Battery powered

	ME110-1	ME110-2
Version	closed (C) front part only (F)	
Display	6 ½ digits h = 13 mm	
Programmable resolutions	1 - 0.1 - 0.05 - 0.01 mm 0.01 - 0.001 - 1/16 - 1/32 - 1/64 inches 1° - 0.1° - 0.01° - 0.001° angular	
Power supply	3 V (2 LR6 AA batteries)	
Max. counting speed	2 m/sec	4 m/sec
In combination with magnetic band	MP100	MP200
Pole pitch	1+1 mm	2+2 mm
Sensor - magnetic band gap	0.1 ÷ 0.4 mm	0.3 ÷ 2 mm
Accuracy	± 10 µm	± 15 µm
Protection class of sensor	IP 67	IP 67



ME110 E

External power supply

	ME110-1	ME110-2
Version	closed (C) front part only (F)	
Display	6 ½ digits h = 13 mm	
Programmable resolutions	1 - 0.1 - 0.05 - 0.01 mm 0.01 - 0.001 - 1/16 - 1/32 - 1/64 inches 1° - 0.1° - 0.01° - 0.001° angular	
Power supply	external 1.5 ÷ 5 V	
Max. counting speed	2 m/sec	4 m/sec
In combination with magnetic band	MP100	MP200
Pole pitch	1+1 mm	2+2 mm
Sensor - magnetic band gap	0.1 ÷ 0.4 mm	0.3 ÷ 2 mm
Accuracy	± 10 µm	± 15 µm
Protection class of sensor	IP 67	IP 67



MP – Magnetic bands for MTS and MTV sensors

- Magnetic band composed by a magnetized plastoferrite strip, supported by a stainless steel carrier on which a bi-adhesive tape is pre-mounted. Extremely quick sticking and easy fixing.

MP100

Pole pitch 1+1 mm

Pole pitch	1+1 mm (for sensor mod. MTS P or MTV P)
Accuracy at 20°C	± 30 µm/m standard ± 15 µm/m special
Width	10 mm
Thickness	1.3 mm
Max. length	50 m
Minimum bending radius	130 mm
Magnetic band weight	65 g/m
Cover weight	25 g/m

MP200

Pole pitch 2+2 mm

Pole pitch	2+2 mm (for sensor mod. MTS M or MTV M)
Accuracy at 20°C	± 30 µm/m standard ± 15 µm/m special
Width	10 mm
Thickness	1.3 mm
Max. length	50 m
Minimum bending radius	130 mm
Magnetic band weight	65 g/m
Cover weight	25 g/m
Accessories	stainless steel cover for protection CV103 aluminium support SP202

MP200Z

Pole pitch 2+2 mm – With zero ref.

Pole pitch	2+2 mm (for sensor mod. MTS MxxZ)
Reference indexes	positioned upon request, from left or right, at pitches of 4 mm or multiples
Accuracy at 20°C	± 30 µm/m standard ± 15 µm/m special
Width	10 mm
Thickness	1.3 mm
Max. length	50 m
Minimum bending radius	130 mm
Magnetic band weight	65 g/m
Cover weight	25 g/m
Accessories	stainless steel cover for protection CV103 aluminium support SP202

MP500

Pole pitch 5+5 mm

Pole pitch	5+5 mm (for sensor mod. MTS H or MTV H)
Accuracy at 20°C	± 30 µm/m standard ± 15 µm/m special
Width	10 mm
Thickness	1.3 mm
Max. length	25 m
Minimum bending radius	130 mm
Magnetic band weight	65 g/m
Cover weight	25 g/m
Accessories	stainless steel cover for protection CV103 aluminium support SP202



Every magnetic band is supplied with a certificate of metrological inspection.

ACCESSORIES – Cover and support

CV103 Stainless steel cover for protection

Non-magnetic stainless steel cover on which a bi-adhesive tape is pre-mounted for a quick sticking and an easy fixing to the magnetic band.

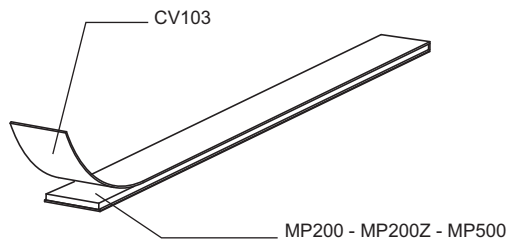

Width 10 mm – Thickness 0.3 mm.
To be applied on magnetic tapes
MP200 – MP200Z – MP500.

SP202 Aluminium support

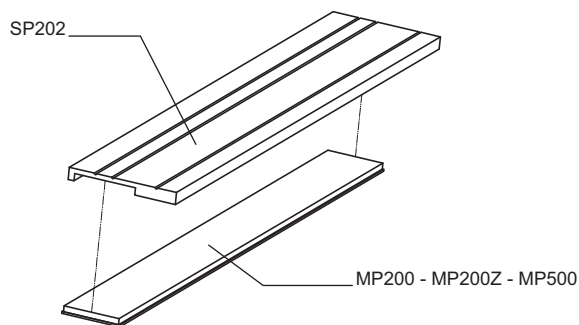

To be fixed on the machine to support the magnetic band.

ATTENTION! It is not possible to use the support SP202 if the magnetic bands are already covered by CV103.



One of the production phases of the magnetic band, whose manufacturing know-how has been directly developed by GIVI MISURE.

Rotary encoders



Models

- EN58
- EN38
- EPC
- EN413
- VE413 FQ – VE413 FT
- ACCESSORIES

EN58 – Incremental encoders Ø 58 mm



- Incremental rotary encoder based on optical principle.
- Small overall dimensions for installation on small machine-tools.
- Wide range of pulses/rev. up to 64000 ppr.
- Bidirectional signals with zero references.
- Output by connector or cable, radial or axial position.
- Ring for high protection.
- Housing and body made of aluminium.
- High rotational precision.
- Excellent signal stability.
- Protected against inversion of power supply polarity and short circuit on output ports.
- Wide range of features.
- Custom-built features on request.

The manufacturing quality of optical discs guarantees the high precision of encoders.

EN58 SC

Semi-hollow shaft

Available pulses	5 + 64000 ppr
Max. rotating speed	moment. 12000 rpm permanent 8000 rpm
Centering Ø	36 mm
Fixing	no. 3 screws M4 at 120°
Shaft Ø mm	6 - 8 - 9.52 - 10 - 12 - 14 - 15 others on request
Power supply	5 V ± 5% or 5 + 28 V ± 5%
Protection class	IP 65
Output	LINE DRIVER / PUSH-PULL / OPEN COLLECTOR
Max. frequency	300 kHz
Electrical protections	inversion of polarity and short circuit



EN500

Centering Ø 50 mm

Available pulses	5 + 64000 ppr
Max. rotating speed	moment. 12000 rpm permanent 8000 rpm
Centering Ø	50 mm
Fixing	no. 3 screws M4 at 120°
Shaft Ø mm	6x10 - 8x20 - 9.52x20 - 10x20 others on request
Power supply	5 V ± 5% or 5 + 28 V ± 5%
Protection class	IP 65 or IP 67 (optional)
Output	LINE DRIVER / PUSH-PULL / OPEN COLLECTOR
Max. frequency	300 kHz
Electrical protections	inversion of polarity and short circuit



EN590

Flange Ø 90 mm

Available pulses	5 + 64000 ppr
Max. rotating speed	moment. 12000 rpm permanent 8000 rpm
Centering Ø	80 mm
Fixing	no. 3 screws M5 at 120°
Shaft Ø mm	8x20 - 9.52x20 - 10x20 others on request
Power supply	5 V ± 5% or 5 + 28 V ± 5%
Protection class	IP 65 or IP 67 (optional)
Output	LINE DRIVER / PUSH-PULL / OPEN COLLECTOR
Max. frequency	300 kHz
Electrical protections	inversion of polarity and short circuit



EN600

Centering Ø 31.75 mm

Available pulses	5 + 64000 ppr
Max. rotating speed	moment. 12000 rpm permanent 8000 rpm
Centering Ø	31.75 mm
Fixing	no. 4 holes Ø 5.5 mm
Shaft Ø mm	6x10 - 8x20 - 9.52x20 - 10x20 others on request
Power supply	5 V ± 5% or 5 + 28 V ± 5%
Protection class	IP 65 or IP 67 (optional)
Output	LINE DRIVER / PUSH-PULL / OPEN COLLECTOR
Max. frequency	300 kHz
Electrical protections	inversion of polarity and short circuit



EN531

Centering Ø 31.75 mm

Available pulses	5 + 64000 ppr
Max. rotating speed	moment. 12000 rpm permanent 8000 rpm
Centering Ø	31.75 mm
Fixing	no. 3 screws M5 at 120°
Shaft Ø mm	6x10 - 8x20 - 9.52x20 - 10x20 others on request
Power supply	5 V ± 5% or 5 + 28 V ± 5%
Protection class	IP 65 or IP 67 (optional)
Output	LINE DRIVER / PUSH-PULL / OPEN COLLECTOR
Max. frequency	300 kHz
Electrical protections	inversion of polarity and short circuit



EN536

Centering Ø 36 mm

Available pulses	5 + 64000 ppr
Max. rotating speed	moment. 12000 rpm permanent 8000 rpm
Centering Ø	36 mm
Fixing	no. 3 screws M3 at 120°
Shaft Ø mm	6x10 - 8x20 - 9.52x20 - 10x20 others on request
Power supply	5 V ± 5% or 5 + 28 V ± 5%
Protection class	IP 65 or IP 67 (optional)
Output	LINE DRIVER / PUSH-PULL / OPEN COLLECTOR
Max. frequency	300 kHz
Electrical protections	inversion of polarity and short circuit



EN5036

Centering Ø 50 mm

Available pulses	5 + 64000 ppr
Max. rotating speed	moment. 12000 rpm permanent 8000 rpm
Centering Ø	50 mm
Fixing	no. 3 screws M5 at 120°
Shaft Ø mm	6x10 - 8x20 - 9.52x20 - 10x20 others on request
Power supply	5 V ± 5% or 5 + 28 V ± 5%
Protection class	IP 65 or IP 67 (optional)
Output	LINE DRIVER / PUSH-PULL / OPEN COLLECTOR
Max. frequency	300 kHz
Electrical protections	inversion of polarity and short circuit



EN650

Centering Ø 50 mm

Available pulses	5 + 64000 ppr
Max. rotating speed	moment. 12000 rpm permanent 8000 rpm
Centering Ø	50 mm
Fixing	no. 4 holes Ø 5.5 mm
Shaft Ø mm	6x10 - 8x20 - 9.52x20 - 10x20 others on request
Power supply	5 V ± 5% or 5 + 28 V ± 5%
Protection class	IP 65 or IP 67 (optional)
Output	LINE DRIVER / PUSH-PULL / OPEN COLLECTOR
Max. frequency	300 kHz
Electrical protections	inversion of polarity and short circuit



EN38 – Incremental encoders Ø 38 mm

- High-precision, small-sized incremental rotary encoders based on optical principle.
- Output by sealed cable in radial or axial position.
- High degree of robustness. Flange, body and housing made of aluminium.
- Excellent rotational precision and signal stability.
- Protected against inversion of power-supply polarity and short circuit on output ports.

EN38 ON

Standard fixing

Available pulses	5 ÷ 3600 ppr
Max. rotating speed	moment. 8000 rpm permanent 6000 rpm
Centering Ø	33 mm
Fixing	no. 4 screws M3 at 90°
Shaft Ø mm	6 - 8
Power supply	5 V ± 5% or 5 ÷ 28 V ± 5%
Protection class	IP 65 or IP 67 (optional)
Output	LINE DRIVER / PUSH-PULL
Max. frequency	120 kHz
Electrical protections	inversion of polarity and short circuit



EN38 MN

Double fixing system

Available pulses	5 ÷ 3600 ppr
Max. rotating speed	moment. 8000 rpm permanent 6000 rpm
Centering Ø	20 mm
Fixing	no. 3 screws M3 at 120° no. 4 screws M3 at 90°
Shaft Ø mm	6 - 8
Power supply	5 V ± 5% or 5 ÷ 28 V ± 5%
Protection class	IP 65 or IP 67 (optional)
Output	LINE DRIVER / PUSH-PULL
Max. frequency	120 kHz
Electrical protections	inversion of polarity and short circuit



EN38 FN

Fixing by threaded nut

Available pulses	5 ÷ 3600 ppr
Max. rotating speed	moment. 8000 rpm permanent 6000 rpm
Fixing	by threaded nut M18x1
Shaft Ø mm	6 - 8
Power supply	5 V ± 5% or 5 ÷ 28 V ± 5%
Protection class	IP 65 or IP 67 (optional)
Output	LINE DRIVER / PUSH-PULL
Max. frequency	120 kHz
Electrical protections	inversion of polarity and short circuit



EN38 BB

With square flange

Available pulses	5 ÷ 3600 ppr
Max. rotating speed	moment. 8000 rpm permanent 6000 rpm
Centering Ø	20 mm
Fixing	no. 4 holes Ø 3.2 mm
Shaft Ø mm	6 - 8
Power supply	5 V ± 5% or 5 ÷ 28 V ± 5%
Protection class	IP 65 or IP 67 (optional)
Output	LINE DRIVER / PUSH-PULL
Max. frequency	120 kHz
Electrical protections	inversion of polarity and short circuit



EPC

Rack and pinion encoder

Available pulses	5 ÷ 2500 ppr
Fixing	no. 4 screws M6
Shaft Ø mm	8 - 10
Connector output	axial - radial
Thrust spring positioning	left - right
Power supply	5 V ± 5% or 12 ÷ 24 V ± 5%
Output	LINE DRIVER / PUSH-PULL
Max. frequency	100 kHz



EN413

Incremental encoder Ø 41.3 mm

Available pulses	50 ÷ 500 ppr
Max. rotating speed	6000 rpm
Centering Ø	20 mm
Fixing	no. 2 screws M4
Hollow shaft Ø mm	6
Cable output	radial
Power supply	5 V ± 5% or 12 ÷ 24 V ± 5%
Protection class	IP 40
Output	LINE DRIVER / PUSH-PULL
Max. frequency	50 kHz



VE413 FQ

Electronic handwheel - square flange

Available pulses	50 - 100 - 500 ppr
Fixing	no. 4 flat head screws M5
Cable output	radial
Connection	cable - terminal board
Power supply	5 V ± 5% or 12 ÷ 24 V ± 5%
Protection class	IP 40
Output	LINE DRIVER
Max. frequency	50 kHz



VE413 FT

Electronic handwheel - round flange

Available pulses	50 - 100 - 500 ppr
Fixing	no. 3 screws M4x10 at 120°
Cable output	radial
Connection	cable - terminal board
Power supply	5 V ± 5% or 12 ÷ 24 V ± 5%
Protection class	IP 40
Output	LINE DRIVER
Max. frequency	50 kHz



ACCESSORIES – Metric wheels and supports

SV200

Metric wheel circumference 200 mm

Wheel circumference	200 mm
Available pulses	2 + 3600 ppr
Power supply	5 V ± 5% or 5 + 28 V ± 5%
Output	LINE DRIVER / PUSH-PULL / OPEN COLLECTOR
Protection class	IP 65 or IP 67 (optional)
Cable - connector	m 1/2/3/...cable - connector 7/10/12 pins
Weight	320 + 100 g
Type of rubber	smooth - knurled
Accessories	supporting arm



SV500

Metric wheel circumference 500 mm

Wheel circumference	500 mm
Available pulses	2 + 3600 ppr
Power supply	5 V ± 5% or 5 + 28 V ± 5%
Output	LINE DRIVER / PUSH-PULL / OPEN COLLECTOR
Protection class	IP 65 or IP 67 (optional)
Cable - connector	m 1/2/3/...cable - connector 7/10/12 pins
Weight	320 + 280 g
Type of rubber	smooth - knurled
Accessories	supporting arm

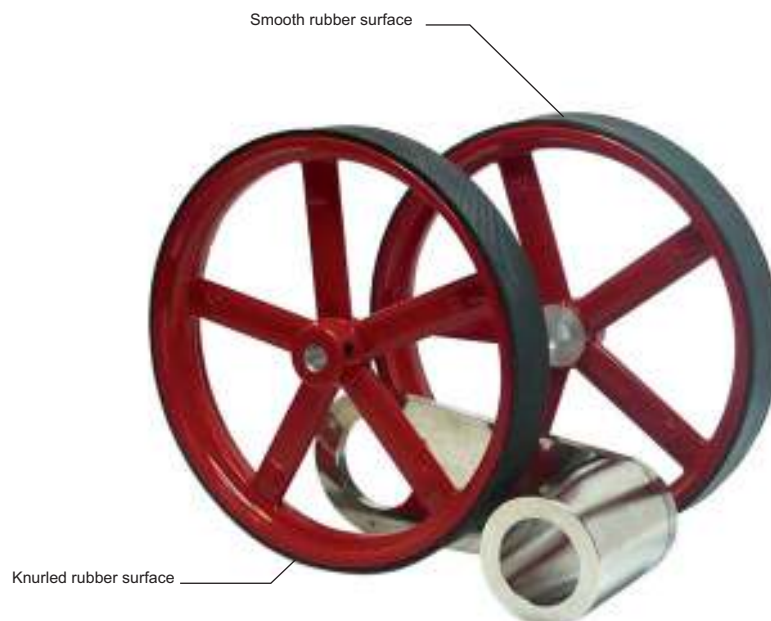

ACCESSORIES – Shaft-encoder couplings

HELI-CAL coupling

Dimensions (D x L)	Hole diameter (d1 0 ÷ 0.05)	Hole diameter (d2 0 ÷ 0.05)	Fixing	Max Tm
20x20 mm	6 mm	6 mm	no. 4 screws M3	1.1 Nm
20x20 mm	8 mm	8 mm	no. 4 screws M3	1.0 Nm
25x24 mm	6 mm	6 mm	no. 4 screws M4	2.9 Nm
25x24 mm	8 mm	8 mm	no. 4 screws M4	2.6 Nm
25x24 mm	9.53 mm	9.53 mm	no. 4 screws M4	2.2 Nm
25x24 mm	10 mm	10 mm	no. 4 screws M4	2.2 Nm



SPRING coupling

Dimensions (D x L)	Hole diameter (d1 0 ÷ 0.05)	Fixing	Max Tm
16x35 mm	6 - 8 - 10 mm	no. 2 screws M4	1.0 Nm



PGFX coupling

Dimensions (D x L)	Hole diameter (d1 0 ÷ 0.05)	Shaft diameter (d)	Fixing	Max Tm
26x28 mm	6 - 8 mm	18 mm	no. 2 screws M3	0.3 Nm
48x48 mm	10 - 12 mm	25 mm	no. 2 screws M4	1.3 Nm



OLDHAM coupling

Dimensions (D x L)	Hole diameter (d1 0 ÷ 0.05)	Fixing	Max Tm
16x35 mm	6 - 8 - 10 mm	no. 4 screws M4	1.0 Nm



Digital readouts



Models

- ME510
- ME518
- ME600
- ME800
- VI700
- VI900
- ACCESSORIES

ME510 – Single-axis digital readout

- Up to 6 digits displayed, with floating decimal point.
- Resolutions up to 1 μm .
- Internal rewritable memory (no buffer battery required).
- Correction factor, midpoint calculation, relay output and many other functions available.
- Applicable on several machine-tools performing cuttings or machining at a preset size, polishing, bending, grinding, straightening, etc., in several sectors, such as: wood, sheet metal, marble, textile, rubber, etc. processing machines.

ME510

Standard version

Display	6 high-efficiency digits h = 17 mm
Signal input	2 square waves out of phase $90^\circ \pm 5^\circ$ and zero ref. 5 Vdc or 12 Vdc
Power supply	230 Vac $\pm 10\%$ - 50/60 Hz 30 mA 110 Vac $\pm 10\%$ - 60 Hz 60 mA 24 Vac $\pm 10\%$ - 50/60 Hz 300 mA
Memory	permanent for configuration and "user" settings (last data operating memory)
Available resolutions	100 - 50 - 20 - 10 - 5 - 2 - 1 μm 1° - 0.5° - 0.2° - 0.1° - 0.05° - 0.02° - 0.01°



ME510 UR2 – ME510 S

Version with options

Display	6 high-efficiency digits h = 17 mm
Signal input	2 square waves out of phase $90^\circ \pm 5^\circ$ and zero ref. 5 Vdc or 12 Vdc
Power supply	230 Vac $\pm 10\%$ - 50/60 Hz 30 mA 110 Vac $\pm 10\%$ - 60 Hz 60 mA 24 Vac $\pm 10\%$ - 50/60 Hz 300 mA
Memory	permanent for configuration and "user" settings (last data operating memory)
Available resolutions	100 - 50 - 20 - 10 - 5 - 2 - 1 μm 1° - 0.5° - 0.2° - 0.1° - 0.05° - 0.02° - 0.01°
Options	serial output RS-232 relay output static relay AC - static relay DC



MAIN FUNCTIONS ME510

- | | |
|---------------------------------------|-----------------------------------|
| • SELF-TEST | • INVERSION OF COUNTING DIRECTION |
| • PRESETTING LOAD QUOTA | • MIDPOINT CALCULATION |
| • RESETTING/PRESETTING OF A DIMENSION | • SETTING LOAD QUOTA |
| • VARIABLE RESOLUTION | • MEMORY CLEARING |
| • MM/INCH CONVERSION MODE | • LINEAR CORRECTION |
| • ABS/INC COUNTING | • ANGULAR READING |
| • SCALE ZERO REF. | • RELAY OUTPUT ACTIVATION (opt.) |
| • DISABLING OF SCALE ZERO REF. | • SETTING OF RELAY QUOTA (opt.) |
| • COUNTING MODE | |

ME518 – Single-axis digital readout, with 7-digit display

- Up to 7 digits displayed, with floating decimal point.
- Resolutions up to 0.5 μm .
- Internal rewritable memory (no buffer battery required).
- Correction factor, midpoint calculation, relay output and many other functions available.
- Applicable on several machine-tools performing cuttings or machining at a preset size, polishing, bending, grinding, straightening, etc., in several sectors such as: wood, sheet metal, marble, textile, rubber, etc. processing machines.

ME518

Standard version

Display	7 high-efficiency digits h = 13 mm
Signal input	2 square waves out of phase $90^\circ \pm 5^\circ$ and zero ref. 5 Vdc or 12 Vdc
Power supply	230 Vac $\pm 10\%$ - 50/60 Hz 30 mA 110 Vac $\pm 10\%$ - 60 Hz 60 mA 24 Vac $\pm 10\%$ - 50/60 Hz 300 mA
Memory	permanent for configuration and "user" settings (last data operating memory)
Available resolutions	200 - 100 - 50 - 20 - 10 - 5 - 2 - 1 - 0.5 μm 1° - 0.5° - 0.2° - 0.1° - 0.05° - 0.02° - 0.01° 0.005° - 0.002° - 0.001°



ME518 UR2 – ME518 S

Version with options

Display	7 high-efficiency digits h = 13 mm
Signal input	2 square waves out of phase $90^\circ \pm 5^\circ$ and zero ref. 5 Vdc or 12 Vdc
Power supply	230 Vac $\pm 10\%$ - 50/60 Hz 30 mA 110 Vac $\pm 10\%$ - 60 Hz 60 mA 24 Vac $\pm 10\%$ - 50/60 Hz 300 mA
Memory	permanent for configuration and "user" settings (last data operating memory)
Available resolutions	200 - 100 - 50 - 20 - 10 - 5 - 2 - 1 - 0.5 μm 1° - 0.5° - 0.2° - 0.1° - 0.05° - 0.02° - 0.01° 0.005° - 0.002° - 0.001°
Options	serial output RS-232 relay output static relay AC - static relay DC



MAIN FUNCTIONS ME518

- | | |
|---------------------------------------|----------------------------------|
| • SELF-TEST | • RADIUS/DIAMETER CONVERSION |
| • PRESETTING LOAD QUOTA | • MIDPOINT CALCULATION |
| • RESETTING/PRESETTING OF A DIMENSION | • SETTING LOAD QUOTA |
| • VARIABLE RESOLUTION | • MEMORY CLEARING |
| • MM/INCH CONVERSION MODE | • LINEAR CORRECTION |
| • ABS/INC COUNTING | • ANGULAR READING |
| • SCALE ZERO REF. | • RELAY OUTPUT ACTIVATION (opt.) |
| • DISABLING OF SCALE ZERO REF. | • SETTING OF RELAY QUOTA (opt.) |
| • COUNTING MODE | • SEXAGESIMAL DEGREES READING |
| • INVERSION OF COUNTING DIRECTION | |

ME600 – Multi-axis digital readout, without auxiliary display

- Up to 3 axes displayed, up to 4 input axes.
- 7-digit display h = 17 mm.
- Variable resolution, selectable up to 0.5 µm.
- Tactile watertight front keyboard, protected against electrostatic discharges.
- Easy and immediate use thanks to dedicated keys and coded functions.
- Acoustic and visual signals guiding the operator.
- Excellent operating reliability.
- High versatility: applicable on different types of machine-tools, since it is keyboard-programmed.
- Options available, such as relay outputs and serial output.

ME622 – ME623

With 2 displays

Display	7 high-efficiency digits h = 17 mm
Input axes	2 - 3
Applicable to	lathe - milling machine - boring machine - etc.
Signal input per axis	2 square waves out of phase 90° ± 5° and zero ref. 5 Vdc or 12 Vdc
Power supply	230 Vac ± 10% - 50/60 Hz 30 mA 110 Vac ± 10% - 60 Hz 60 mA 24 Vac ± 10% - 50/60 Hz 300 mA
Memory	permanent for configuration and special functions
Available resolutions	200 - 100 - 50 - 20 - 10 - 5 - 2 - 1 - 0.5 µm 1° - 0.5° - 0.2° - 0.1° - 0.05° - 0.02° - 0.01° 0.005° - 0.002° - 0.001°
Protection class	keyboard IP 67 rear panel IP 42
Options	relay outputs (1/2/3) serial output RS-232 standard autonomy battery 1.5 h double autonomy battery 3 h



2-axis version

ME633 – ME634

With 3 displays

Display	7 high-efficiency digits h = 17 mm
Input axes	3 - 4
Applicable to	lathe - milling machine - boring machine - etc.
Signal input per axis	2 square waves out of phase 90° ± 5° and zero ref. 5 Vdc or 12 Vdc
Power supply	230 Vac ± 10% - 50/60 Hz 30 mA 110 Vac ± 10% - 60 Hz 60 mA 24 Vac ± 10% - 50/60 Hz 300 mA
Memory	permanent for configuration and special functions
Available resolutions	200 - 100 - 50 - 20 - 10 - 5 - 2 - 1 - 0.5 µm 1° - 0.5° - 0.2° - 0.1° - 0.05° - 0.02° - 0.01° 0.005° - 0.002° - 0.001°
Protection class	keyboard IP 67 rear panel IP 42
Options	relay outputs (1/2/3) serial output RS-232 standard autonomy battery 1.5 h double autonomy battery 3 h



3-axis version

MAIN FUNCTIONS ME600

- SELF-TEST/ MANUAL TEST
- MIDPOINT CALCULATION
- MEMORY CLEARING
- CONSTANT PITCH
- INVERSION OF COUNTING DIRECTION
- RESETTING/PRESETTING OF A DIMENSION
- MM/INCH CONVERSION MODE
- ANGULAR READING
- SEXAGESIMAL DEGREES READING
- ABS/INC COUNTING
- SCALE ZERO REF.
- 100 OFFSET TOOL SELECTION
- VARIABLE RESOLUTION
- RADIUS/DIAMETER CONVERSION
- SCALE FACTOR
- LINEAR CORRECTION
- AXIS COUPLING

ME800 – Multi-axis digital readout, with auxiliary LCD display

- Up to 3 axes displayed, up to 4 input axes.
- Auxiliary back-lit LCD display.
- 7-digit main display h = 17 mm.
- Variable resolution, selectable up to 0.5 μm .
- Tactile watertight front keyboard, protected against electrostatic discharges.
- Easy and immediate use thanks to dedicated keys and coded functions.
- Acoustic and visual signals guiding the operator.
- Excellent operational reliability.
- High versatility: applicable to different types of machine-tools, since it is keyboard-programmed.
- Options available, such as relay outputs and serial output.
- Special cover made of shockproof expanded tecnopolymer with conductive treatment for protection against interference.
- Circuit engineered in order to eliminate any kind of harness or hard wiring.
- Strict selection of components after at least 1000 h of BURN-IN cycles.

ME822 – ME823

With 2 displays

Display	7 high-efficiency digits h = 17 mm
Input axes	2 - 3
Applicable to	lathe - milling machine - boring machine - etc.
Signal input per axis	2 square waves out of phase $90^\circ \pm 5^\circ$ and zero ref. 5 Vdc or 12 Vdc
Power supply	230 Vac $\pm 10\%$ - 50/60 Hz 30 mA 110 Vac $\pm 10\%$ - 60 Hz 60 mA 24 Vac $\pm 10\%$ - 50/60 Hz 300 mA
Memory	permanent for configuration and special functions
Available resolutions	200 - 100 - 50 - 20 - 10 - 5 - 2 - 1 - 0.5 μm $1^\circ - 0.5^\circ - 0.2^\circ - 0.1^\circ - 0.05^\circ - 0.02^\circ - 0.01^\circ - 0.005^\circ$ $0.002^\circ - 0.001^\circ$
Protection class	keyboard IP 67 rear panel IP 42
Options	relay outputs (1/2/3) serial output RS-232 standard autonomy battery 1.5 h double autonomy battery 3 h constant cut output



2-axis version



All the instrumentation is power supplied and undergoes a burn-in process, for at least 1000 h, at 50°C. Inside the instrument, the apex temperature is 70+75°C.

ME833 – ME834

With 3 displays

Display	7 high-efficiency digits h = 17 mm
Input axes	3 - 4
Applicable to	lathe - milling machine - boring machine - etc.
Signal input per axis	2 square waves out of phase $90^\circ \pm 5^\circ$ and zero ref. 5 Vdc or 12 Vdc
Power supply	230 Vac $\pm 10\%$ - 50/60 Hz 30 mA 110 Vac $\pm 10\%$ - 60 Hz 60 mA 24 Vac $\pm 10\%$ - 50/60 Hz 300 mA
Memory	permanent for configuration and special functions
Available resolutions	200 - 100 - 50 - 20 - 10 - 5 - 2 - 1 - 0.5 μm $1^\circ - 0.5^\circ - 0.2^\circ - 0.1^\circ - 0.05^\circ - 0.02^\circ - 0.01^\circ - 0.005^\circ$ $0.002^\circ - 0.001^\circ$
Protection class	keyboard IP 67 rear panel IP 42
Options	relay outputs (1/2/3) serial output RS-232 standard autonomy battery 1.5 h double autonomy battery 3 h constant cut output



3-axis version

MAIN FUNCTIONS

- SELF-TEST/MANUAL TEST
- MIDPOINT CALCULATION
- MEMORY CLEARING
- CONSTANT PITCH
- INVERSION OF COUNTING DIRECTION
- RESETTING/PRESETTING OF A DIMENSION
- MM/INCH CONVERSION MODE
- ANGULAR READING
- SEXAGESIMAL DEGREES READING
- ABS/INC COUNTING
- SCALE ZERO REF.
- 100 OFFSET TOOL SELECTION
- VARIABLE RESOLUTION
- RADIUS/DIAMETER CONVERSION
- SCALE FACTOR
- LINEAR CORRECTION
- AXIS COUPLING
- CALCULATOR

SPECIAL FUNCTIONS

- LANGUAGE SELECTION
- ROUND FLANGE
- WEIGHT OF MATERIALS CALCULATION
- CIRCUMFERENCE CENTER
- MIRROR IMAGE
- 100 ORIGINS
- CONE INCLINATION CALCULATION
- THREAD CALCULATION
- TIP SPEED CALCULATION
- ROTATION SPEED CALCULATION
- RELAY OUTPUT
- SERIAL OUTPUT RS-232
- CONSTANT CUT

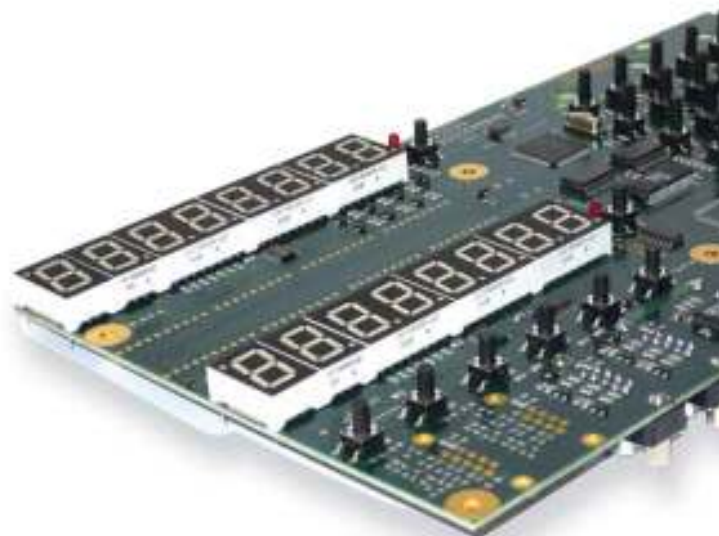

VI700 – Multi-axis digital readout, with LED display

- Compact-designed, modern, functional digital readout.
- Diagnostic of readout and optical scales.
- Resolutions up to 0.5 μm .
- Reading of coded references (in combination with NCS scale).
- Universal software for any kind of machine tool.
- Software upgrade through serial port.
- Program store for 1000 blocks.
- Option: flush-mounted version (on a panel).
- Easy and immediate use of several dedicated functions.

VI722 – VI723

With 2 displays

Display	7 high-efficiency digits h = 17 mm
Signal input per axis	2 square waves out of phase $90^\circ \pm 5^\circ$ and synchronized index
Available resolutions	200 - 100 - 50 - 20 - 10 - 5 - 2 - 1 - 0.5 μm $1^\circ - 0.5^\circ - 0.2^\circ - 0.1^\circ - 0.05^\circ - 0.02^\circ$ $0.01^\circ - 0.005^\circ - 0.002^\circ - 0.001^\circ$
Readout protection	keyboard IP 67 rear panel IP 42
Input axes	2 - 3
Applicable to	lathe - milling machine - boring machine - etc.
LCD	with LCD / without LCD
Power supply	230 Vac $\pm 10\%$ - 50/60 Hz 50 mA 110 Vac $\pm 10\%$ - 60 Hz 100 mA 24 Vac $\pm 10\%$ - 50/60 Hz 450 mA
Version	standard or flush-mounted



2-axis version

VI733L – VI734L

With 3 displays and LCD

Display	7 high-efficiency digits h = 17 mm
Signal input per axis	2 square waves out of phase $90^\circ \pm 5^\circ$ and synchronized index
Available resolutions	200 - 100 - 50 - 20 - 10 - 5 - 2 - 1 - 0.5 μm $1^\circ - 0.5^\circ - 0.2^\circ - 0.1^\circ - 0.05^\circ - 0.02^\circ$ $0.01^\circ - 0.005^\circ - 0.002^\circ - 0.001^\circ$
Readout protection	keyboard IP 67 rear panel IP 42
Input axes	3 - 4
Applicable to	lathe - milling machine - boring machine - etc.
Power supply	230 Vac $\pm 10\%$ - 50/60 Hz 50 mA 110 Vac $\pm 10\%$ - 60 Hz 100 mA 24 Vac $\pm 10\%$ - 50/60 Hz 450 mA
Version	standard or flush-mounted



3-axis version with LCD

VI733 – VI734

With 3 green displays

Display	7 high-efficiency digits h = 17 mm
Signal input per axis	2 square waves out of phase $90^\circ \pm 5^\circ$ and synchronized index
Available resolutions	200 - 100 - 50 - 20 - 10 - 5 - 2 - 1 - 0.5 μm $1^\circ - 0.5^\circ - 0.2^\circ - 0.1^\circ - 0.05^\circ - 0.02^\circ$ $0.01^\circ - 0.005^\circ - 0.002^\circ - 0.001^\circ$
Readout protection	keyboard IP 67 rear panel IP 42
Input axes	3 - 4
Applicable to	lathe - milling machine - boring machine - etc.
LCD	with LCD / without LCD
Power supply	230 Vac $\pm 10\%$ - 50/60 Hz 50 mA 110 Vac $\pm 10\%$ - 60 Hz 100 mA 24 Vac $\pm 10\%$ - 50/60 Hz 450 mA
Version	standard or flush-mounted



3-axis version with green displays

MAIN FUNCTIONS

- SELF-TEST
- DEVICE DIAGNOSTIC
- INVERSION OF COUNTING DIRECTION
- ABS/INC COUNTING
- MM/INCH CONVERSION MODE
- RADIUS/DIAMETER CONVERSION
- VARIABLE RESOLUTION
- SCALE ZERO REF.
- MEMORY CLEARING
- RESETTING/PRESETTING OF A DIMENSION
- ANGULAR READING
- SEXAGESIMAL DEGREES READING
- CALCULATOR
- AXIS COUPLING
- DISPLAYING W AXIS
- RECALLING OF SPECIAL FUNCTIONS
- 100 TOOL OFFSETS
- 100 ORIGINS OF THE AXIS
- SETTING THE TYPE OF SPINDLE ROTATION SPEED
- CONSTANT PITCH
- INCLINED CONSTANT PITCH
- LINEAR CORRECTION
- NON-LINEAR CORRECTION
- SCALE FACTOR
- CIRCUMFERENCE CENTER
- MIDPOINT CALCULATION
- MIRROR IMAGE
- ROUND FLANGE
- SPECIAL ROUND FLANGE
- PROGRAMMING THE MEMORY BLOCKS
- SERIAL OUTPUT RS-232
- SETTING PRINTING LINE SPACINGS
- ENABLING THE AUTOMATIC QUOTA TRANSMISSION

FUNCTIONS LCD VERSION (VI700 L)

- LANGUAGE SELECTION
- CONE INCLINATION CALCULATION
- AUTOMATIC CONE INCLINATION CALCULATION
- THREAD CALCULATION
- WEIGHT OF MATERIALS CALCULATION
- TIP SPEED CALCULATION
- ANGULAR SPEED CALCULATION
- SCALE VALUE SET
- DISPLAYING AXIS SPEED
- DISPLAYING RECALLED TOOL

VI900 – Multi-axis digital readout, touch screen color LCD

New

- Compact-designed, modern, functional digital readout.
- 5.7" touch-screen color, back-lit LCD TFT panel which allows every single axis to be displayed.
- Up to 4 axes displayed.
- USB, Touch Probe, CAN Bus and serial RS-232 interfaces.
- Touch-screen pen provided.
- Resolutions up to 0.1 μm .
- Diagnostic of readout and optical scales.
- Reading of coded references (in combination with NCS scale).
- High versatility: universal software for any kind of machine tool, upgrade through serial port.
- Program store for 1000 blocks.
- Visualization of function execution. HELP on-line.
- Easy and immediate use of several dedicated functions.
- Option: flush-mounted version (on a panel).

Panel	color, back-lit, 5.7" LCD TFT
Signal input per axis	2 square waves displaced $90^\circ \pm 5^\circ$ and synchronized index
Available resolutions	1000 - 500 - 200 - 100 - 50 - 20 - 10 5 - 2 - 1 - 0.5 - 0.2 - 0.1 μm 1° - 0.5° - 0.2° - 0.1° - 0.05° - 0.02° 0.01° - 0.005° - 0.002° - 0.001°
Digital readout protection	keyboard IP 67 rear panel IP 42
Input axes	2 - 3 - 4
Applicable to	lathe - milling machine - boring machine - etc.
Power supply	230 Vac $\pm 10\%$ - 50/60 Hz 60 mA 110 Vac $\pm 10\%$ - 60 Hz 120 mA 24 Vac $\pm 10\%$ - 50/60 Hz 500 mA
Version	standard or flush-mounted



4-axis version

MAIN FUNCTIONS

- | | |
|--|---|
| • LANGUAGE SELECTION | • LINEAR CORRECTION |
| • SELF-TEST | • NON-LINEAR CORRECTION |
| • DEVICE DIAGNOSTIC | • SCALE FACTOR |
| • INVERSION OF COUNTING DIRECTION | • CIRCUMFERENCE CENTER |
| • ABS/INC COUNTING | • MIDPOINT CALCULATION |
| • MM/INCH CONVERSION MODE | • MIRROR IMAGE |
| • RADIUS/DIAMETER CONVERSION | • ROUND FLANGE |
| • VARIABLE RESOLUTION | • SPECIAL ROUND FLANGE |
| • SCALE ZERO REF. | • PROGRAMMING THE MEMORY BLOCKS |
| • MEMORY CLEARING | • CONE INCLINATION CALCULATION |
| • RESETTING/PRESETTING OF A DIMENSION | • AUTOMATIC CONE INCLINATION CALCULATION |
| • ANGULAR READING | • THREAD CALCULATION |
| • SEXAGESIMAL DEGREES READING | • WEIGHT OF MATERIALS CALCULATION |
| • CALCULATOR | • TIP SPEED CALCULATION |
| • AXIS COUPLING | • ANGULAR SPEED CALCULATION |
| • RECALLING OF SPECIAL FUNCTIONS | • SCALE VALUE SET |
| • 100 TOOL OFFSETS | • DISPLAYING AXIS SPEED |
| • 100 ORIGINS OF THE AXIS | • DISPLAYING RECALLED TOOL |
| • SETTING THE TYPE OF SPINDLE ROTATION SPEED | • SERIAL OUTPUT RS-232 |
| • CONSTANT PITCH | • SETTING PRINTING LINE SPACINGS |
| • INCLINED CONSTANT PITCH | • ENABLING THE AUTOMATIC QUOTA TRANSMISSION |

ACCESSORIES – Supporting arms

MOD. 1 Vertical fixing

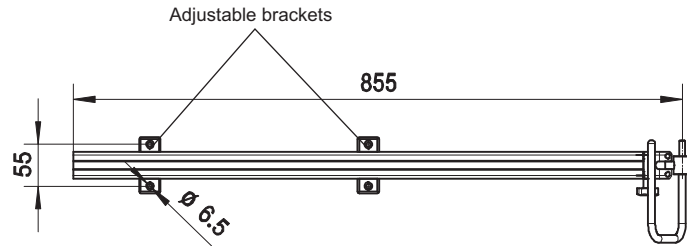

MOD. 2 Vertical fixing with single hinged arm

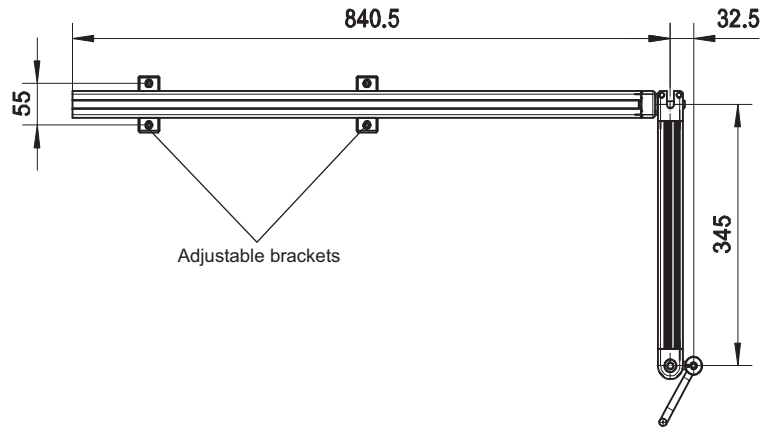

MOD. 3 Wall fixing with single hinged arm

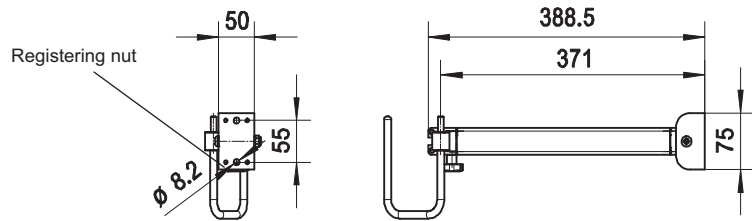

MOD. 4 Surface fixing with single hinged arm

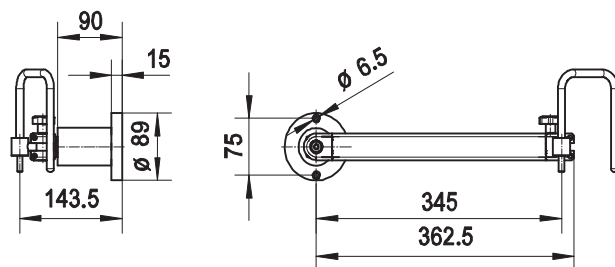

MOD. 5

Wall fixing with double hinged arm

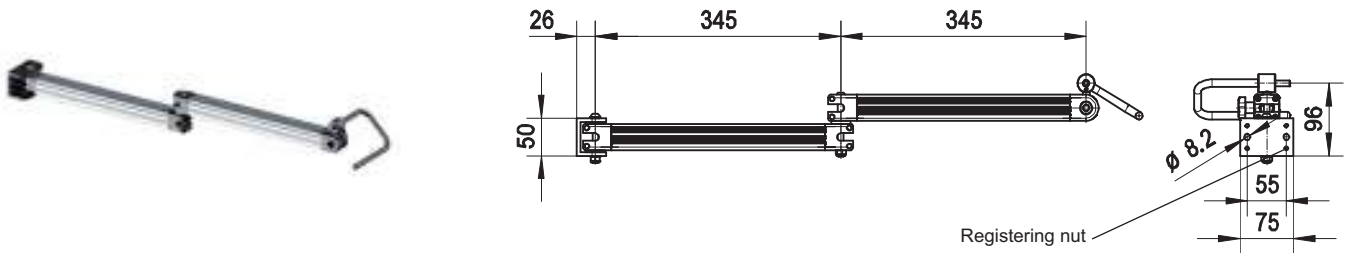

MOD. 6

Surface fixing with double hinged arm

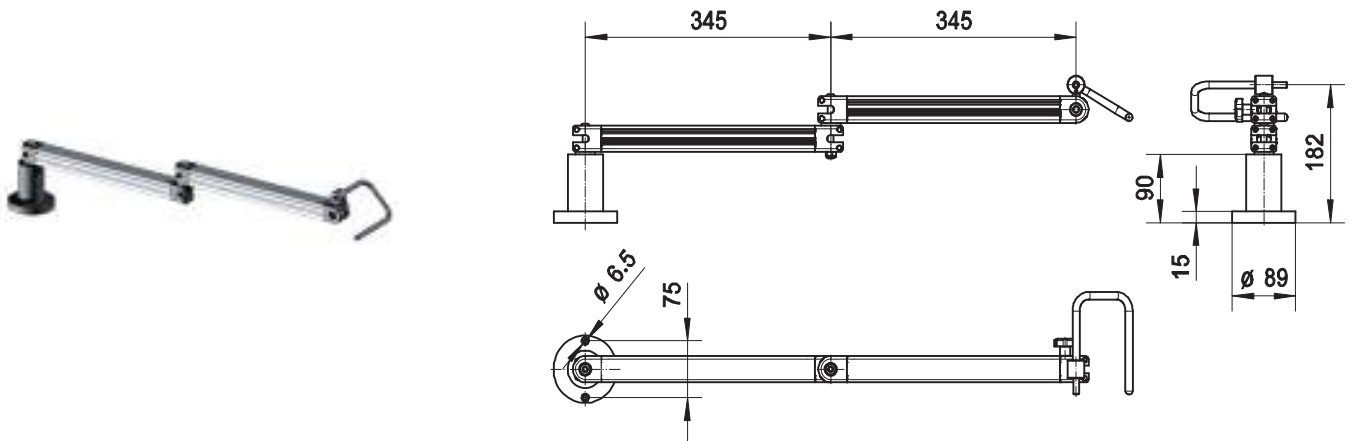

MOD. 7

Surface fixing

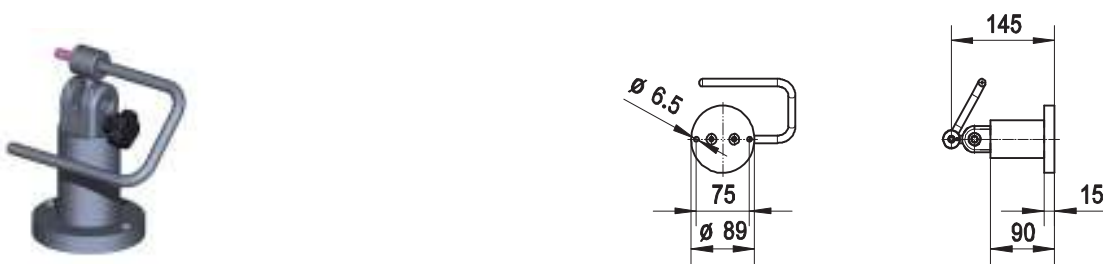

MOD. ARGO

Vertical fixing on round bar \varnothing 25 mm

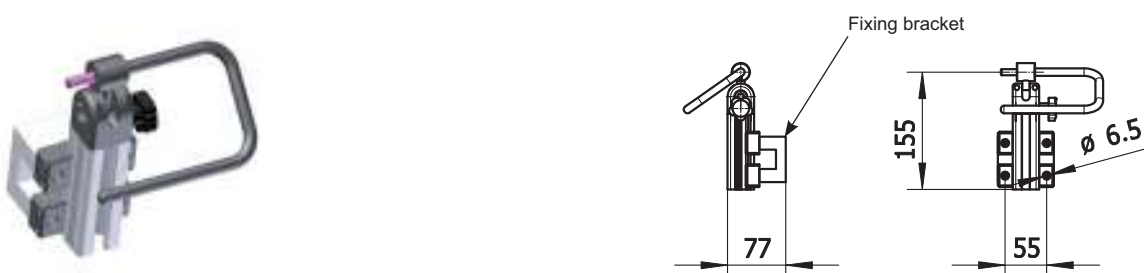

Position controllers



Models

THESI 310
THESI 320

THESI 310 – Single-axis position controller

New

- THESI 310 position controller can control shifting and positioning of one axis in 3 different operating modes:
 - MANUAL or SEMI-AUTOMATIC by keyboard.
 - AUTOMATIC on the basis of a memorized program.
- Memorization of up to 99 PROGRAMS with 20 positions each. Up to 99 repetitions can be matched to each position (the program cycle is composed by the position and its respective repetitions).
- 90 Vac to 230 Vac power supply or 24 Vac power supply with selector.
- Manufactured with 16 bit microcontroller, 256K FLASH and 8K RAM memory in single-chip mode.
- Optoisolated inputs
START, STOP, INCREASE CYCLE, DEVIATION, PRESET.
- Voltage-free contact outputs
OK POSITION, ENABLING WITH CONTROL INTERLOCK
FEED / BACK, SLOW / FAST.
- ± 10 Vdc analog output
FEED / BACK, SLOW / FAST.
- Can be installed on bench or built in.

THESI 310 DI

With relay outputs (digital)

Display	POSITION: 6 high-efficiency digits h = 13 mm and negative sign CYCLES: 2 high-efficiency digits h = 9 mm PROGRAMS: 2 high-efficiency digits h = 9 mm
Signal input per axis	2 square waves out of phase $90^\circ \pm 10^\circ$ and zero ref.
Axis input frequency	20 kHz _{MAX}
Linear resolution	200 - 100 - 50 - 20 - 10 - 5 - 2 - 1 μ m
Protection class	keyboard IP 65 rear panel IP 40
Encoder power supply	5 Vdc or 12 Vdc 120 mA _{MAX}
Power	10 W _{MAX}
Power supply	90 to 230 Vac $\pm 10\%$ - 50/60 Hz 24 Vac $\pm 10\%$ - 50/60 Hz
Digital outputs	N.O. relay contacts
Inputs	optoisolated
Connections	by removable terminal block
Dimensions	front panel: 72x144 mm – depth: 126 mm



THESI 310 AN

With analog output

Display	POSITION: 6 high-efficiency digits h = 13 mm and negative sign CYCLES: 2 high-efficiency digits h = 9 mm PROGRAMS: 2 high-efficiency digits h = 9 mm
Signal input per axis	2 square waves out of phase $90^\circ \pm 10^\circ$ and zero ref.
Axis input frequency	20 kHz _{MAX}
Linear resolution	200 - 100 - 50 - 20 - 10 - 5 - 2 - 1 μ m
Protection class	keyboard IP 65 rear panel IP 40
Encoder power supply	5 Vdc or 12 Vdc 120 mA _{MAX}
Power	10 W _{MAX}
Power supply	90 to 230 Vac $\pm 10\%$ - 50/60 Hz 24 Vac $\pm 10\%$ - 50/60 Hz
Analog output	± 10 Vdc optoisolated
Inputs	optoisolated
Connections	by removable terminal block
Dimensions	front panel: 72x144 mm – depth: 126 mm



THESI 320 – Two-axis position controller

New

- **THESI 320** position controller can control shifting and positioning of two axes in 3 different operating modes:
 - MANUAL or SEMI-AUTOMATIC by keyboard.
 - AUTOMATIC on the basis of a memorized program.
- End of program output.
- Independent axes as for configurations and parameters.
- 3 generic auxiliary inputs.
- Memorization of up to 99 PROGRAMS with 20 positions each. Up to 99 repetitions can be matched to each position (the program cycle is composed by the position and its respective repetitions).
- 90 Vac to 230 Vac power supply or 24 Vac power supply with selector.
- Manufactured with 16 bit microcontroller, 256K FLASH and 8K RAM memory in single-chip mode.
- Optoisolated inputs
START, STOP, INCREASE CYCLE, DEVIATION, PRESET.
- Voltage-free contact outputs
OK POSITION, ENABLING WITH CONTROL INTERLOCK
FEED / BACK, SLOW / FAST.
- ± 10 Vdc analog output
FEED / BACK, SLOW / FAST.
- Can be installed on bench or built in.

THESI 320 DI

With relay outputs (digital)

Display	POSITION: 6 high-efficiency digits h = 13 mm and negative sign
	CYCLES: 2 high-efficiency digits h = 13 mm
	PROGRAMS: 2 high-efficiency digits h = 13 mm
Signal input per axis	2 square waves out of phase $90^\circ \pm 10^\circ$ and zero ref.
Axis input frequency	20 kHz _{MAX}
Linear resolution	200 - 100 - 50 - 20 - 10 - 5 - 2 - 1 μ m
Protection class	keyboard IP 65 rear panel IP 40
Encoder power supply	5 Vdc or 12 Vdc 120 mA _{MAX}
Power	10 W _{MAX}
Power supply	90 to 230 Vac $\pm 10\%$ - 50/60 Hz
	24 Vac $\pm 10\%$ - 50/60 Hz
Digital outputs	N.O. relay contacts
Inputs	optoisolated
Connections	by removable terminal block
Dimensions	front panel: 100x193 mm – depth: 135 mm



THESI 320 AN

With analog output

Display	POSITION: 6 high-efficiency digits h = 13 mm and negative sign
	CYCLES: 2 high-efficiency digits h = 13 mm
	PROGRAMS: 2 high-efficiency digits h = 13 mm
Signal input per axis	2 square waves out of phase $90^\circ \pm 10^\circ$ and zero ref.
Axis input frequency	20 kHz _{MAX}
Linear resolution	200 - 100 - 50 - 20 - 10 - 5 - 2 - 1 μ m
Protection class	keyboard IP 65 rear panel IP 40
Encoder power supply	5 Vdc or 12 Vdc 120 mA _{MAX}
Power	10 W _{MAX}
Power supply	90 to 230 Vac $\pm 10\%$ - 50/60 Hz
	24 Vac $\pm 10\%$ - 50/60 Hz
Analog output	± 10 Vdc optoisolated
Inputs	optoisolated
Connections	by removable terminal block
Dimensions	front panel: 100x193 mm – depth: 135 mm



Worldwide sales offices and service centers:



GREAT BRITAIN
6 Lumina, Martindale Road
Croft Business Park
CH 62 3PT BROMBOROUGH, Wirral
Tel.: +44 151 3344555
Fax: +44 151 3341616

HONG KONG
Flat 811, 8/F., Hing Wah Centre,
82-84 ToKwaWan Road, Kowloon,
HONG KONG
Tel.: +852 2333 7679
Fax: +852 2333 7176

INDIA
VITC Export Bhavan, 1st Block
Plot No. 488, KIADB Complex 14th
Cross,
IV Phase, Peenya Indl. Area
560 058 BANGALORE
Tel.: +91 80 41272559
Fax: +91 80 41171374

IRAN
Second floor, no. 29
3rd Golbon Alley, 11th Fath St.
Fath Blvd., TEHRAN
Tel.: +98 21 66791775
Fax: +98 21 66791776

ISRAEL
31 Habarzel St.
69710 TEL AVIV
Tel.: +972 3 6470471
Fax: +972 3 6470472

POLAND
ul. Przemyslowa 47
43100 TYCHY
Tel.: +48 32 7801322
Fax: +48 32 7801322

RUSSIA
Paveletskay Nab. 2, Str.7
115114 MOSCOW
Tel.: +7 495 9814844
Fax: +7 495 9814843

SOUTH AFRICA
P.O. BOX 3221
7602 MATIELAND
Tel.: +27 21 946 1925
Fax: +27 21 946 1926

SOUTH KOREA
5731-1, Daejeo 2-Dong
Gangseo-Gu,
618-810 BUSAN
Tel.: +82 51 517 5514
Fax: +82 51 517 5515

SPAIN
C/. La Garsa, 33
08450 Lleinars del Valles
(BARCELONA)
Tel.: +34 93 8713057
Fax: +34 93 8713182

SWEDEN
Metallgatan 1 B
262 72 ANGELHOLM
Tel.: +46 431 448454
Fax: +46 431 14190

SYRIA
P.O. BOX 12850
DAMASCUS
Tel.: +963 11 3325519
Fax: +963 11 3342639

TAIWAN
7F-3, No. 13, Wu-Chun, 1 Rd., 248
HSIN-CHUANG, TAIPEI HSIEN
Tel.: +886 2 22995422
Fax: +886 2 22995423

THAILAND
145/35 Soi Sukhumwit 105 (La Salle 1)
Sukhumwit Rd., Kwang Bangna, KE
10260 BANGKOK
Tel.: +66 2 749 1048
Fax: +66 2 749 1049

TURKEY
Tophane, Bogazkesen Cad. No.149/4
34433 ISTANBUL
Tel.: +90 212 252 90 66
Fax: +90 212 292 00 20

Optical Scales for Press Brakes:

Perpa Tic. Mer. B Blok Kat 11 Nr. 1740
Okmeydani-Perpa
34385 ISTANBUL
Tel.: +90 212 320 13 83
Fax: +90 212 320 13 86

AUSTRALIA
6/9 Mavis Street
Revesby, NSW 2212
Tel.: +61 2 97722289
Fax: +61 2 97722289

BRASIL
Av. Gov. Pedro de Toledo, 205
13735-074 MOCOCA-SP
Tel.: +55 19 3656 3140
Fax: +55 19 3656 3140

CHINA
Rm 406, No. 681,
Huai An Rd.
200041 SHANGHAI
Tel.: +86 21 32271250
Fax: +86 21 62770735

CZECH REPUBLIC
Delnická 3272
40747 VARNSDORF
Tel.: +420 412 374 320
Fax: +420 412 374 327

DENMARK
Blokken 42
DK-3460 BIRKERØD
Tel.: +45 4582 4440
Fax: +45 4582 5550

FINLAND
Pyynikintie, 25
33230 TAMPERE
Tel.: +358 3 3432450
Fax: +358 3 3433878

FRANCE
53 Avenue Carnot
94100 SAINT MAUR
Tel.: +33 1 48867794
Fax: +33 1 42831195

GERMANY
Rheinstraße 37
64367 MUHLTAL
Tel.: +49 6151 503320
Fax: +49 6151 5033222





GIVI MISURE S.r.l.
Via Assunta, 57 - 20054 Nova Milanese (MI) - Italy
Tel.: +39 0362.36.61.26 - Fax: +39 0362.36.68.76
www.givimisure.it info@givimisure.it